

The First Name in Digital Audio

DENON

A/V Amplifier

AVC-A10SE



DENON

INPUT SELECTOR



HOME
THEATER
TAPE MON



SURROUND SPEAKER
PHONO
CD
TUNER
AUX
VIDEO
TV/VIDEO
VCR-1
VCR-2
V-ALIA
RE-TRK



THE SURROUND EX

PHONES



SURROUND MODE

STEREO	STEREO	STEREO	STEREO	STEREO	STEREO	CH SELECT	DOWN	UP
STEREO	STEREO	STEREO	STEREO	STEREO	STEREO	MODE	MODE	MODE
MULT						REC / MULT		

A/V Amplifier

AVC-A10SE

The World's First A/V Amplifier with THX Surround EX

Denon's tradition of excellence and innovation in audio and home theater continues with the introduction of the AVC-A10SE, the world's first A/V Amplifier that combines Dolby Digital, DTS, Lucasfilm's THX Ultra 5.1 post-processing and also the newest surround technology, Lucasfilm's THX Surround EX decoding. Denon's history of world's firsts in digital A/V technology began in 1995 with the introduction of the AVP-A1, the first component to provide Dolby Digital decoding with Lucasfilm THX 5.1 post-processing, followed by the AVC-A1, the world's first A/V Amplifier with Dolby Digital and THX. The introduction in 1999 of the AVC-A1D brought together for the first time the combined technologies of Dolby Digital, DTS, and THX 5.1 in an A/V Amplifier.

Denon's newest A/V Amplifier, the AVC-A10SE, continues the AVC-A1D's heritage of excellence and innovation by incorporating the newest surround technology – Lucasfilm's THX Surround EX decoding, and is another world's first for Denon. Optimized for the latest in DVD soundtracks and for future audio formats, the AVC-A10SE brings a new level of sonic performance in home theater A/V Amplifiers.

Providing 125 watts of power into each of the 5 amplifier channels, the AVC-A10SE's all-discrete power amplifier section features separates-quality design, providing power and detail with both music and movie soundtracks. From a whisper-quiet foundation to a thundering climax, the AVC-A10SE's power amp section delivers the full fidelity and authority of even the most demanding soundtracks and music performances.

Denon's Design Integrity philosophy is to develop components that faithfully reproduce the musician's artistry and the movie director's vision with total fidelity. The AVC-A10SE is the latest in Denon's distinguished line-up of award-winning home theater components.



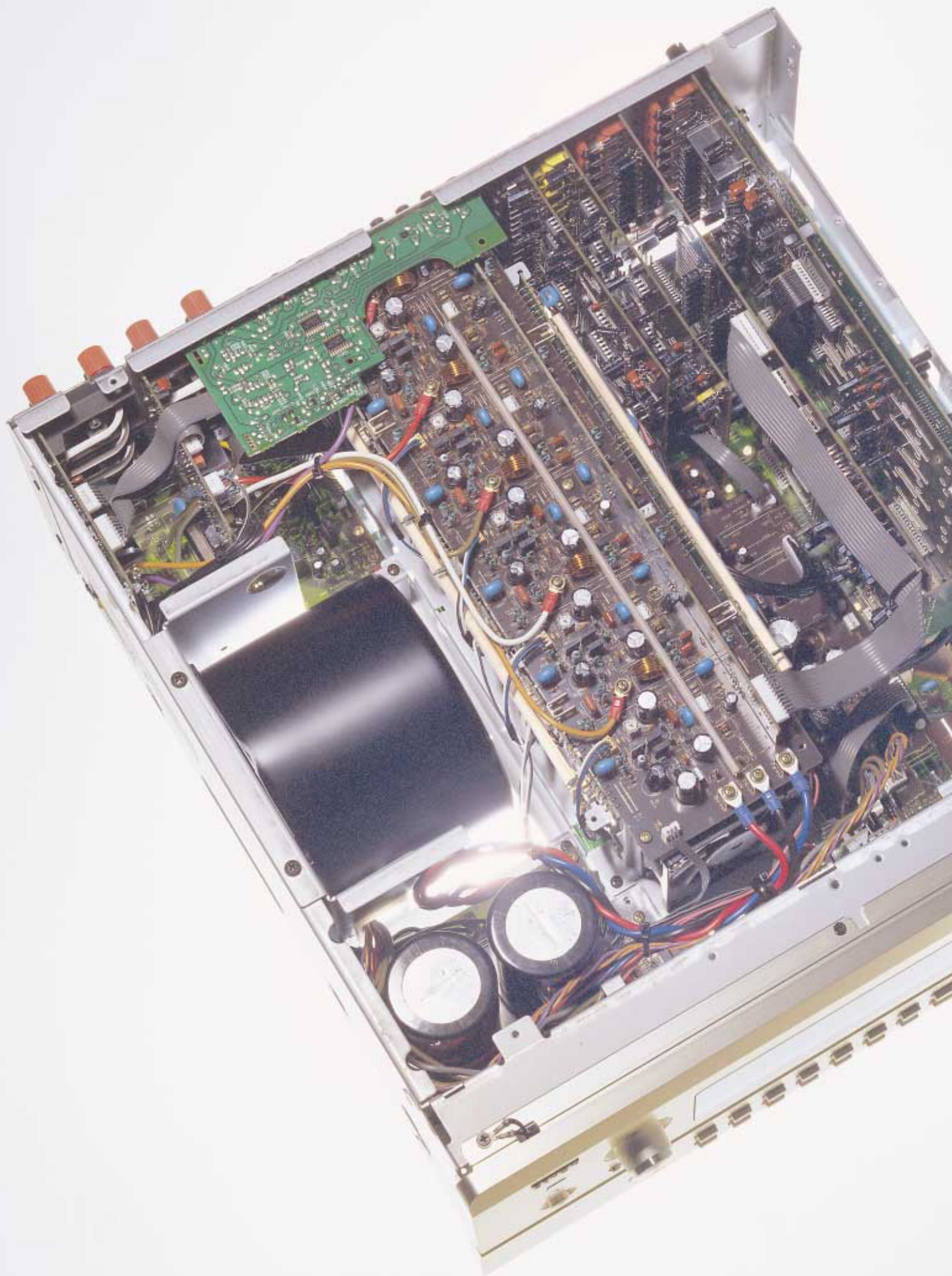



■ Discrete Power Amplifier Section with Equal Power and Equal Response In All Channels, Features THX Ultra Certification

The AVC-A10SE's all discrete power amp stage features high current, low distortion power output devices, able to drive virtually any modern loudspeaker system configuration, regardless of impedance or efficiency. Lucasfilm's most stringent THX Ultra certification provides your assurance that the AVC-A10SE can deliver the full authority and dynamic impact of modern motion picture soundtracks in standard and large size home theater environments. The AVC-A10SE is equipped with Denon's smart cooling system featuring a volume and temperature sensing fan, which provides necessary cooling during extended periods of high power operation, yet is completely inaudible and unobtrusive during quiet passages.

■ Robust Power Supply

The THX Ultra-certified power amp section is supplied with abundant reserves of energy due to the power supply's high current power transformer, and large capacity high current storage capacitors. Individual separate power supplies are also provided for the low level analog and digital circuit blocks, to eliminate mutual interference. THX Ultra certification assures highest quality sound at virtually any volume level, from whisper quiet to thundering crescendo.

■ New D.D.S.C. (Dynamic Discrete Surround Circuit) - Digital

Denon's unique approach to surround decoder design, DDSC-Digital, employs optimized circuit blocks and elements for each individual surround decoder function, including highest performance analog-to-digital conversion stage featuring 20 bit precision, dedicated DSP processors featuring all-digital domain decoding. For the most accurate analog reproduction, the AVC-A10SE features a stereo analog bypass mode, which preserves stereo analog purity and transparency, while providing digital bass management accuracy for optimum subwoofer response.

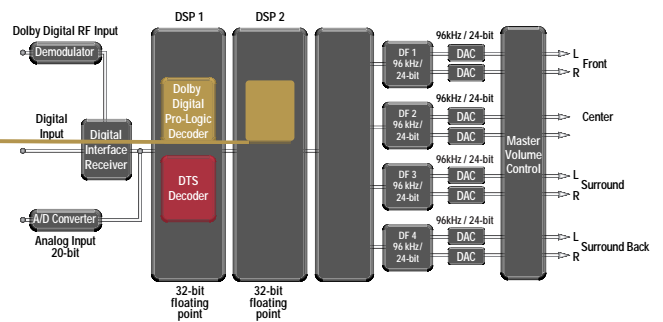

■ Dual Analog Devices SHARC 32 Bit Floating Point DSP

The heart of the AVC-A10SE's surround decoder section features two high speed 32 bit floating point DSP processors, same as used in the AVC-A1D, bringing separates-quality surround decoding performance to the amplifier category. The first DSP performs the Dolby Digital and DTS surround decoding, while the second DSP provides the THX post-processing, Surround EX decoding, other DSP environment simulations and bass management functions, all in digital domain with the highest accuracy possible.

■ 24 Bit, 96 kHz D/A Converters For All Channels

Unlike conventional A/V components that use integrated low-bit codecs, the AVC-A10SE features highest quality multiple D/A converter chips. Featuring Analog Devices real 24 bit, 96 kHz D/A conversion on all audio channels, the AVC-A10SE provides separates-quality D/A conversion performance.

THX Ultra & THX Surround EX, For Accurate Movie Soundtrack Reproduction

The AVC-A10SE is the world's first A/V Amplifier to feature Lucasfilm's THX Ultra 5.1 post-processing along with the latest Lucasfilm THX Surround EX decoding function, providing the most accurate reproduction of the newest multi-channel motion picture soundtracks.

THX Surround EX, developed jointly by Lucasfilm and Dolby, made its debut in movie theaters with the release of the movie "Star Wars – Episode 1: The Phantom Menace". Featuring a specially-encoded 5.1 discrete soundtrack, the THX Surround EX function includes a center back surround channel in addition to the left surround and right surround channels, providing heightened spatial realism and more convincing surround imaging.

Now that Surround EX-encoded movies are available for home theater playback, the AVC-A10SE's THX Surround EX function provides thrilling home theater surround sound reproduction. Compared to simpler and less accurate "6.1" unlicensed simulations, the AVC-A10SE's accurate THX Surround EX decoding function provides the full suite of required decoding parameters, and can be automatically or manually selected, according to the program material characteristics.

In addition, the AVC-A10SE surround decoder is DTS ES-compatible, along with accurate decoding of Dolby Digital and DTS 5.1 channel soundtracks, with or without THX 5.1 post-processing.

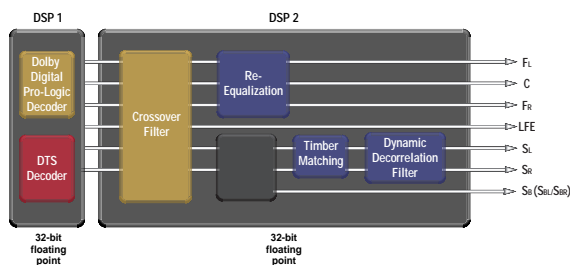

THX Surround EX Auto Mode

Surround EX-encoded movies may have a special data flag which will activate the AVC-A10SE and set it automatically to THX Home Cinema mode with THX Surround EX decoding. Or, you can activate the THX Surround EX function manually, for program sources which do not have the special data flag.

Assignable Power Amplifier Configuration

The AVC-A10SE provides 7.1 channel pre-amp outputs, to allow connection of external power amplifier(s), powered loudspeakers, and amplified subwoofer. To take full advantage of THX Surround EX, connect a mono or stereo amplifier to the surround back pre-amp outputs to drive the surround back loudspeaker(s). Or, use the AVC-A10SE assignable power amp configuration to utilize the internal front left/right power amplifiers to drive the surround back speakers, and then connect an external stereo power amplifier, such as the Denon POA-3200, to the main left and right speakers. The AVC-A10SE provides great system configuration flexibility.

Widescreen 7.1 Channel Playback of Conventional Sources – A Denon Original Technology

Denon's new Widescreen 7.1 function provides thrilling 7 speakers (plus subwoofer) reproduction of conventional stereo, matrix encoded, and discrete 5.1 program sources. This proprietary Denon DSP function provides full panoramic surround presentation, utilizing the three front loudspeakers, the two surround loudspeakers, and if configured, the center back loudspeakers. Enjoy total 360 degree surround immersion, with movie soundtracks and your favorite musical performances also.

Dual Surround Mode Speaker Selection

Denon's exclusive Dual Surround Mode Speaker Selector provides two sets of surround speaker connections, for two different types of surround speakers and different placements in the home theater. Choose side-mounted diffuse surround speakers for the most realistic and enveloping movie soundtrack reproduction. Choose rear-mounted directional loudspeakers for

the most accurate 5.1 channel music surround reproduction. Only Denon let's you choose the correct surround speaker type and placement, for movie and music surround without compromise.



Music

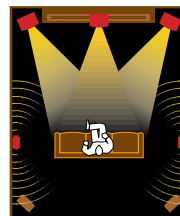

Movie

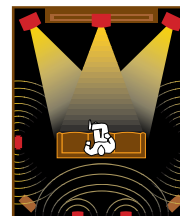

Surround back

6-/8-channel External Inputs For Future Sound Format Upgrade Capability

A full set of 7.1 channel inputs is provided, for future multi-channel audio formats. The AVC-A10SE is fully prepared for the future of multi-channel sound.

Wide-Range Play Capability For Next-Generation Audio

The power amp circuits of the AVC-A10SE have been meticulously designed to reproduce the exceptionally high sound quality with wide frequency response from 10 Hz to 100 kHz in advanced, next-generation audio formats such as DVD-Audio and SACD.

Component Video Switching Capability

In addition to the multiple composite and "S" video connections, the AVC-A10SE provides progressive compatible component video inputs for the DVD and TV/DBS inputs, and a set of wideband component video outputs. The component video switching path is completely transparent, to ensure perfect video quality from even wideband high resolution video sources and high resolution video displays.

On Screen Display

Complicated operations are greatly simplified with the AVC-A10SE's on screen display, which lets you easily and quickly set the optimum system parameters for your home theater configuration.

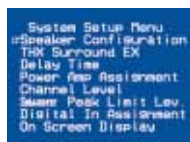

System Setup Menu



Easy setting of speaker configuration

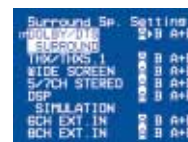

User-friendly guide for making settings

Programmable Learning Remote with Installed IR Codes

The easy-to-use remote features important keys that are shaped and color-coded according to their function, and the remote provides learning capability to accept IR codes from other component's remotes. A built-in code library provides hundreds of codes for popular brands and models of equipment, and the important function keys are self-illuminating in the dark.

Other Features

- Thoroughly Vibration-resistant Structure
- Tone Control Circuit (Front L/R, Center, Subwoofer)
- Record Output Selector

*1. The AVC-A10SE is equipped with a 5-channel amplifier. To hear the 6th and 7th channels used by Surround Back, you need to connect an external amplifier such as the DENON POA-3200.

The signals for the additional channels are output through the Pre Out jacks.

*2. When the Surround Back channel is turned off, the AVC-A10SE processes the signals in the same manner and gives you the same effects as conventional 5.1-channel signals.

*3. The THX Surround EX Auto Mode supports both Dolby Digital and DTS signal sources, and support for DVD and other program sources is planned.



Input/Output Terminals For Every A/V System

Audio Inputs

- 11 Sets Analog Input PHONO, CD, TUNER, DVD, VDP, TV/DBS, V-AUX, VCR-1, VCR-2, MD/TAPE-1, TAPE-2
- 8-ch Analog EXT. Input FRONT L/R, CENTER, SURROUND L/R, EFFECT L/R, SUBWOOFER
- 6-ch Analog EXT. Input FRONT L/R, CENTER, SURROUND L/R, SUBWOOFER
- 5 Sets Digital (Optical) Input OPTICAL X 5
- 3 Sets Digital (Coaxial) Input COAXIAL X 3
- 1 Set Dolby Digital RF Input RF x 1

Audio Outputs

- 8-ch Analog PRE Output FRONT L/R, CENTER, SURROUND L/R, EFFECT(SURROUND BACK) L/R, SUBWOOFER
- 4 Sets Analog REC Output VCR-1, VCR-2, MD/TAPE-1, TAPE-2
- 1 Set Analog Multi Source Output L/R
- 1 Set Digital (Optical) Output OPTICAL

Video Inputs

- 2 Sets Component Video Input DVD, TV/DBS
- 6 Sets Composite Input DVD, VDP, TV/DBS, V-AUX, VCR-1, VCR-2
- 6 Sets S-Video Input DVD, VDP, TV/DBS, V-AUX, VCR-1, VCR-2

Video Outputs

- 1 Set Component Video Output MONITOR
- 4 Sets Composite Output VCR-1, VCR-2, MONITOR-1, MONITOR-2
- 4 Sets S-Video Output VCR-1, VCR-2, MONITOR-1, MONITOR-2

Specifications

Power Amplifier Section

- Rated output *THD figures are power amp stage values. Front / Center / Surround . . . 125 W x 2 / 125 W / 125 W x 2 (8 ohms, 20Hz - 20kHz, 0.05% THD)

Preamplifier Section

- Input sensitivity/Impedance
- PHONO(MM) 2.5 mV/47 kohms
- TUNER, CD, DVD, VDP, TV/DBS, V-AUX, VCR-1 VCR-2, MD/TAPE-1, TAPE-2, FRONT L/R, CENTER, SURROUND L/R, EFFECT L/R, SUBWOOFER 200 mV/47 kohms
- Output level/Load Impedance
- FRONT L/R, CENTER, SURROUND L/R, EFFECT (SURROUND BACK) L/R, SUBWOOFER 1.2 V/10 kohms
- V-AUX, VCR-1 VCR-2, MD/TAPE-1, TAPE-2, MONITOR 200 mV/47 kohms
- Frequency Responce 10 Hz - 100 kHz; +0, -3 dB (DIRECT MODE)
- RIAA deviation ±1 dB (20 Hz - 20 kHz)
- Tone control Treble: ±10 dB at 10 kHz Bass: ±10 dB at 100 Hz

General

- Power supply AC 230 V, 50 Hz
- Power consumption 690 W
- Dimensions 434 (W) x 181 (H) x 494 (D) mm
- Weight 21.5 kg



*Design and specifications are subject to change without notice.
*THX is a registered trademark of Lucasfilm Ltd.
© Lucasfilm Ltd. & TM. All Rights Reserved. Surround EX is a jointly developed technology of THX and Dolby Labs, Inc., and is a trademark of Dolby. Used under authorization.
*Dolby®, "Dolby Digital", "Pro Logic", and the double-D device are registered trademarks of Dolby Laboratories Licensing Corporation.
*DTS is registered trademarks of DTS Technology.



NIPPON COLUMBIA CO., LTD.

14-14, AKASAKA 4-CHOME, MINATO-KU, TOKYO 107-8011, JAPAN www.denon.co.jp

24850200